

## EPC-110/100E/150 SERIES Air/Fuel Ratio Control for Stoichiometric and Lean-Burn Carbureted Engines

- Universal line of air/fuel ratio controls for stoichiometric and lean-burn engines
- Accurate closed-loop control of air/fuel ratio for minimum engine emissions
- Precise full-authority actuation using a range of piston and butterfly-style valves for positive control of fuel
- Modbus-based EPC terminal program and expanded I/O available to implement advanced control strategies
- Fully supports Modbus RTU communications with included PC monitoring software
- CSA-certified for use in Class I, Division 2, Groups C and D hazardous areas

The EPC-110/100E/150 Air/Fuel Ratio Controls are applicable to most carbureted natural gas-fueled engines. This universal line of emission control systems includes three specific models – two of them for stoichiometric applications using a catalytic converter (EPC-110 and EPC-100E), and a third model used exclusively on carbureted, lean-burn engines (EPC-150).

The EPC control systems utilize microprocessor technology, thus allowing for the execution of sophisticated control strategies, and a high-level of application-specific customization. This advanced control and setup functionality is coupled with a complete line of precision, industry-proven fuel control valves. Taken together, these capabilities collectively assure the user of long-term air/fuel ratio stability and reduced engine exhaust emissions.

While stoichiometric and lean-burn engines require fundamentally different oxygen sensing technologies, all EPC systems operate on the basis of closed-loop control to a setpoint utilizing data from an exhaust-mounted oxygen sensor as feedback. With the exhaust oxygen setpoint for lowest emissions entered into the controller, the EPC unit precisely controls the flow of fuel to the engine through the stepper motor valve(s) so as to maintain the target oxygen level during engine operation.

The EPC controllers feature an alphanumeric LCD display which gives operators continual access to critical operating data without the need for non-hazardous area approved hand-held programmers or PC's. Controller operating mode, stepper motor control valve position(s), and exhaust oxygen sensor value(s) are just a few of the display-accessible parameters. To facilitate integration with supervisory monitoring and control systems, the EPC systems fully support the ModBus RTU communications protocol. A full-featured PC-based monitoring and control software package is included with each system at no additional charge to the user.

All EPC systems operate on DC-power, with a typical current draw of 1-3 amps (depending upon model). In remote areas or on applications without DC-power available, power can be provided by the Altronic 24VDC Alternator Power Packages – refer to form ALT for further details.

The entire EPC family of control products is certified by the Canadian Standards Association (CSA) as safe for use in Class I, Division 2, Group C and D hazardous areas.



# Altronic Gas Control Valves

- For use with Altronic EPC-100E, EPC-110 and EPC-150 Air/Fuel Ratio Control Systems and suitable for other gas control applications
- “Universal” valve designs are suitable for use on in-line or V-style, naturally-aspirated or carbureted, and stoichiometric or lean-burn natural gas engine
- Sophisticated digital linear actuator used in all valve models for precise, repeatable control
- Available in both plunger and butterfly-valve configurations
- CSA-certified: Class I, Division 2, Group D hazardous areas

Altronic offers a family of fuel control valves for use with its EPC-100E/110/150 controls and for other gas control applications. These rugged, reliable actuators have become the fuel control standard in the oil and gas and power generation industries for the precision control that they offer and the minimal requirement for maintenance and calibration.

Altronic Gas Control Valves are available in both plunger-style and butterfly configurations (see diagrams to right). “Universal” in their design, they are suitable for use on both in-line and V-style engines, and in both naturally-aspirated and turbocharged configurations. 1.5” NPT, 2.0” NPT, 2.5” NPT, and 3.0” NPT fuel line diameters can be directly accommodated without any need for additional adapter fittings in the line. Please refer to the back page of this brochure for additional ordering details, including general specifications on appropriate valve sizing versus horsepower. A driver module is available for use with all Altronic Gas Control Valves. This module accepts a 4-20mA control signal generated by a third-party controller (such as a PLC or supervisory engine control) and allows the valves to be used in a range of additional applications.

The controls used by the EPC-100E, EPC-110 and EPC-150 systems guarantee full authority over the flow of fuel to the engine. They also avoid the potentially dangerous practice of injecting supplemental fuel gas through a small and potentially unreliable commercial solenoid valve into the air intake of the engine. The incorporation of such solenoid valves into the control strategy of competitive air/fuel ratio control approaches fundamentally limits the total control range to a few percent of the total fuel flow of the engine, and ultimately introduces significant additional safety risks to the equipment and associated personnel.

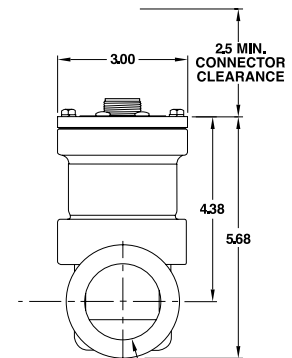
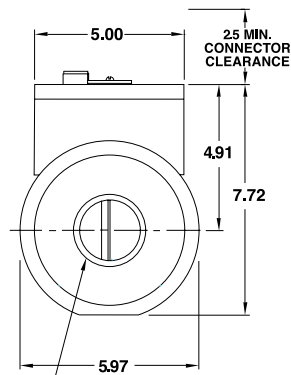
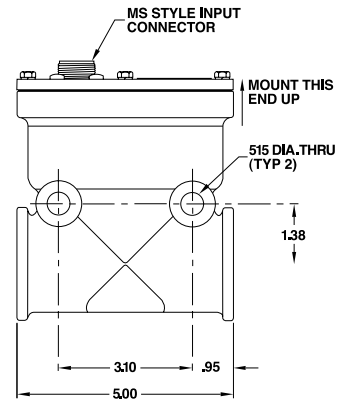
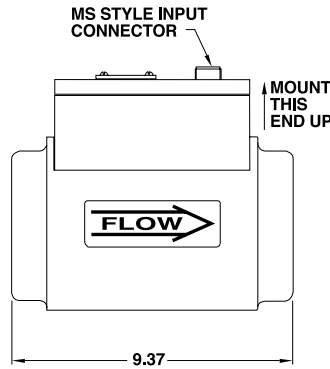

2-0" NPT 691220-1  
 2-1/2" NPT 691225-1  
 3-0" NPT 691230-1  
 STANDARD DEPTH  
 (BOTH ENDS)

1-1/2" NPT  
 STANDARD DEPTH  
 (BOTH ENDS)

## EPC-110 Self-Contained Air/Fuel Ratio Control and Monitoring System for Carbureted, Stoichiometric Engines

- Complete, self-contained air/fuel ratio control/monitoring system for rich-burn engines
  - EPC-110 is housed in a NEMA-4X weather-proof fiber glass enclosure for direct mounting
- Assures maximum efficiency for 3-way catalytic converters
- Single and dual-channel modes for control of in-line or V-type engines
  - single channel can be used on V engines with one pressure regulator/carburetor
- Built-in engine and catalyst temperature monitoring/protection

The Altronic EPC-110 is designed to be used with a 3-way catalytic converter on rich-burn, carbureted, natural gas engines as a means of reducing engine exhaust emissions. Based upon the EPC-100 — used on thousands of gas engines worldwide — this unique system offers effective control of the engine air/fuel ratio as well as engine and catalyst temperature monitoring. A rugged, weather-proof enclosure eliminates the need for mounting inside a separate control panel.

The EPC-110 offers easy installation, maximum application flexibility, ease of operation, and air/fuel ratio stability. The control approach of the EPC-110 assures engine operation at the optimum lambda (exhaust oxygen) setpoint determined to be the point of maximum catalytic converter efficiency and minimum engine emissions. Once determined (through an analysis of the engine exhaust), it is entered into the EPC-110 as the control setpoint. Using a sensor in the exhaust stream to sense the O<sub>2</sub> content, the unit begins to adjust the flow of fuel to meet the proper exhaust oxygen setpoint(s) for minimum emissions. The full-authority fuel control valve(s), mounted in the fuel line between the carburetor and the final cut regulator, assures precise, repeatable control of the air/fuel ratio without resorting to the potentially dangerous strategy of adding fuel to the air intake of the engine.

Monitoring and protecting the engine and catalyst from high temperature-related damage or out-of-compliance operation is a key function of the EPC-110 system. Critical temperatures are monitored against user-adjustable setpoints using type K thermocouples.

Setpoints are tied to one of two normally-closed switch outputs for integration with a safety shutdown panel or supervisory control system. The ERROR ALARM OUTPUT is tripped for all setpoint violations associated with rich/lean control limits, oxygen sensor issues, and other values related to the control functionality. All catalyst temperature setpoint violations (pre-, post-, and differential) prompt the CATALYST TEMPERATURE OUTPUT to trip.

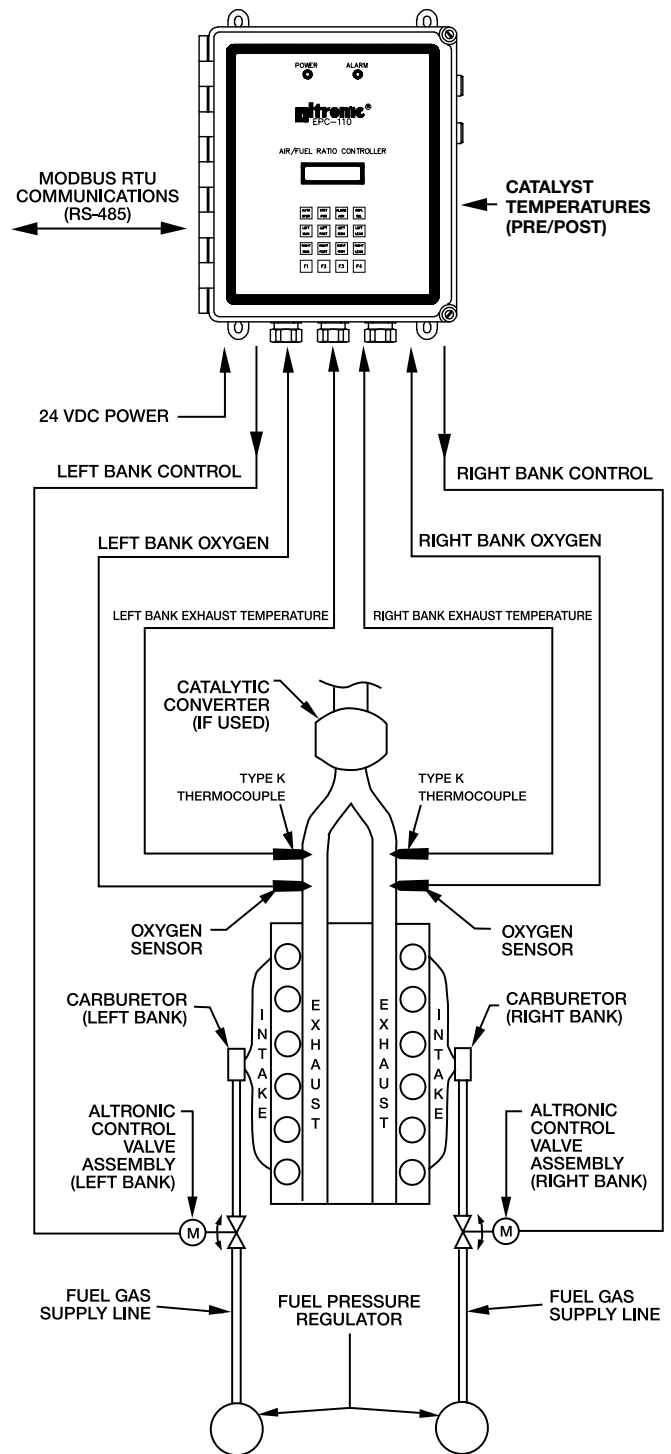

EPC-110 SYSTEM DIAGRAM

# EPC-100E Advanced Air/Fuel Ratio Control System for Carbureted, Stoichiometric Engines

- Designed to optimize the performance of 3-way catalytic converters
- User-customizable control of target lambda setpoint(s) and controller gain adjustment, and access to additional alarm, shutdown, and emissions compliance diagnostics
- Ideal for applications exhibiting ambient, load, or other operational variations
- Universal model available for control of in-line or V-type, naturally-aspirated or turbocharged engines
- Full-authority fuel control eliminates hazardous direct gas admission into the air intake of the engine
- Uses inputs and outputs in EPC-100 units beginning with serial number 5713

The most full-featured of the EPC series, this highly-capable system is unique in its capacity for customization and precision control of the air/fuel ratio, particularly on engines with highly dynamic ambient and/or operational conditions. The EPC-100E combines a proven control approach with the ability to tailor both the lambda setpoint and responsiveness to any excursions in the monitored air/fuel ratio.

The effective, closed-loop control approach in the EPC-100 and the simplicity of installation and setup have made it the control of choice for many users worldwide. In recent years, however, many users have found it necessary or helpful to apply new air/fuel ratio control capabilities as part of a larger effort to secure more consistent or even further reduced exhaust emission levels across a range of operating conditions.

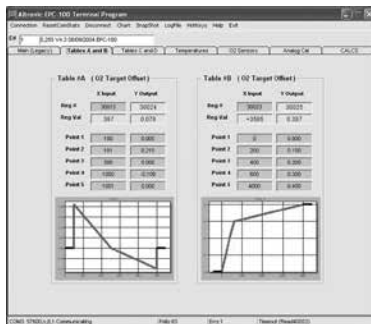

The EPC-100E offers advanced, user-customizable control parameters for the dynamic adjustment of the target O<sub>2</sub> setpoints and controller gains, as well as a means of inhibiting automatic control on the basis of satisfying an external parameter such as load or a post-catalyst O<sub>2</sub> setpoint. This is accomplished through the use of a proprietary, high-level Windows™-based software package. In the example at left, the EPC-100E target O<sub>2</sub> setpoint is dynamically adjusted versus load (in this case derived through an input transducer monitoring air manifold pressure). The user retains the simplicity and familiarity of the EPC-100 system if no enhanced setpoint or gain adjustment control is required, but can easily invoke such functionality if necessary. These enhanced features and capabilities are accessible only via the EPC-100E Terminal Program, their operation and configuration is essentially hidden from the user and resistant to tampering or unauthorized adjustment

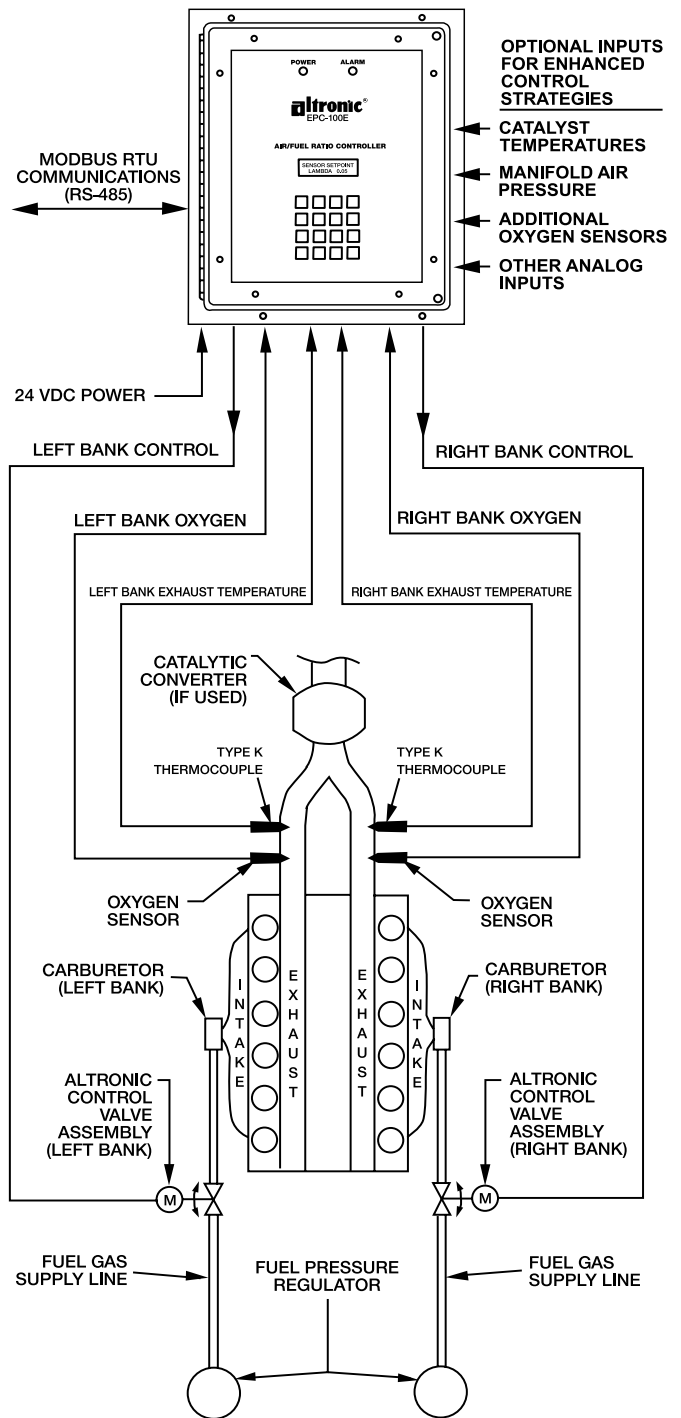

EPC-100E SYSTEM DIAGRAM

## EPC-150 Air/Fuel Ratio Control for Carbureted, Lean-Burn Engines

- Designed on the highly successful EPC-100 control platform
- Applicable to both single and dual regulator, lean-burn engine configurations
- Utilizes a durable and cost-effective lean-burn oxygen sensor for positive, closed loop air/fuel ratio control
- Full-authority fuel control eliminates maintenance-intensive I/Ps and direct gas admission into the air intake
- Reduces engine “lug” conditions and provides accurate air/fuel ratio control at lighter engine loads

The EPC-150 is designed for use on all in-line or V-style, lean-burn, carbureted natural gas-fueled engines. Suitable applications include the highly popular Caterpillar 3400 and 3500-series engines, Waukesha VHP-class lean-burn engines, and most Cummins and Superior models. This innovative control offers reliable, precise, and positive air/fuel ratio control, while maintaining installation and operational simplicity. It also incorporates a number of advanced operating features to address engine conditions specific to lean-burn operation.

The EPC-150 is a closed-loop air/fuel ratio controller designed to precisely adjust fuel delivery to meet and maintain a user-entered exhaust oxygen setpoint. The exhaust oxygen level is continuously monitored by a proven and reliable, yet moderate cost lean-burn oxygen sensor. During system setup, an exhaust gas analyzer is used to determine the oxygen level at which engine-out emissions are at their lowest, with the corresponding setpoint entered into the EPC-150 system as the control setpoint. Thus, as load and other parameters change on the engine, the EPC-150 will maintain the air/fuel ratio to meet the desired exhaust oxygen level, maintaining “in-compliance” engine performance.

A number of features unique to the EPC-150 optimize the controller’s ability to manage fuel-delivery and control issues specific to lean-burn engines. The EPC-150 incorporates a unique control protocol designed to limit “lug” conditions whereby a lightly loaded lean-burn engine becomes incapable of generating sufficient turbo boost to meet the speed setpoint established by the governor. This control approach, which monitors intake air pressure both before and after the throttle plate, enables the controller to automatically offset the oxygen setpoint for richer operation and ultimately increased turbo boost pressures. With the engine operating more smoothly and achieving the necessary RPM, automatic control at the desired oxygen setpoint is then restored. As with all other EPC-150 operating parameters, the point at which such an offset would be made, and its value, is fully adjustable from the keypad of the control unit or remotely using the integral RS-485 ModBus RTU communications system.

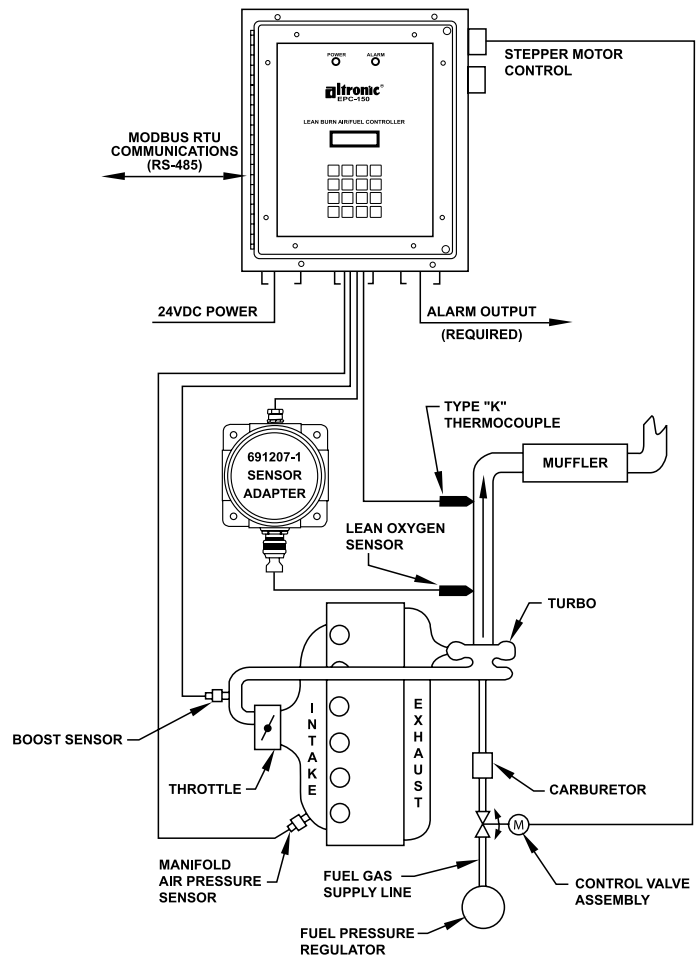

**EPC-150 SYSTEM DIAGRAM**

## Specifications

CONTROLLER	EPC-110-1	EPC-110-2	EPC-100E	EPC-150
<b>INPUTS</b>				
Oxygen Sensor	1	2	4	2
Thermocouples (Type K)	2	4	4	2
Pressure Sensor	—	—	—	4
Analog Voltage (0-5 V.)	—	—	4	—
<b>OUTPUTS</b>				
Fuel Valves	1	2	2	2
Alarm	1	1	1	1
<b>POWER REQUIREMENT</b>				
	10-30 Vdc 1 Amp		10-30 Vdc 1 Amp	24 Vdc 3 Amps
<b>MOUNTING</b>				
	Back		Panel	
<b>DISPLAY</b>				
	Alphanumeric 2x16			
<b>TEMPERATURE</b>				
	-40°F to +185°F / -40°C to +70°C			
<b>COMMUNICATIONS</b>				
	ModBus RTU Protocol (RS-485)			

## Ordering Information

AFR Controller, 1-channel, back mount, stoichiometric.....EPC-110-1  
 AFR Controller, 2-channel, back mount, stoichiometric.....EPC-110-2  
 AFR Controller, 2-channel, panel mount, stoichiometric.....EPC-100E  
 AFR Controller, 2-channel, panel mount, lean burn .....EPC-150

NOTE: Former models EPC-120-1 and EPC-120-2 are replaced by EPC-100E.

Control Valve, 1.5" NPT, below 250 HP .....690154-2  
 Control Valve, 1.5" NPT, 250-1,000 HP .....690154-1  
 Butterfly Valve, 2.0" NPT, 500-1,500 HP .....690220-1  
 Butterfly Valve, 2.5" NPT, 750-2,000 HP .....690225-1  
 Butterfly Valve, 3.0" NPT, 1,000-3,000 HP .....690230-1  
 Accessories Kit, EPC-100E/110, 25 ft. cables .....691310-1  
 Accessories Kit, EPC-100E/110, 50 ft. cables .....691310-2  
 Accessories Kit, EPC-150, 25 ft. cables .....691315-1  
 Accessories Kit, EPC-150, 50 ft. cables .....691315-2

NOTE: Order one Accessory Kit per carburetor.  
 One Type K thermocouple required per carburetor (not supplied in kit).

691310-1 ACCESSORIES KIT  
 Oxygen Sensor .....610621  
 Cable Assembly, Control Valve, 25 ft. ....693005-1  
 Cable Assembly, O<sub>2</sub> Sensor, 25 ft. ....693006-1

691310-2 ACCESSORIES KIT  
 Oxygen Sensor .....610621  
 Cable Assembly, Control Valve, 50 ft. ....693005-2  
 Cable Assembly, O<sub>2</sub> Sensor, 50 ft. ....693006-2

691315-1 ACCESSORIES KIT  
 Oxygen Sensor .....610813  
 Oxygen Sensor Converter .....691207-1  
 Pressure Sensor (qty. 2) .....691204-50  
 Cable Assembly, Control Valve, 25 ft. ....693005-1  
 Cable Assembly, Pressure Sensor, 25 ft. (qty. 2) .....693008-25  
 Cable Assembly, O<sub>2</sub> Sensor, 25 ft. ....693009-1

691315-2 ACCESSORIES KIT  
 Oxygen Sensor .....610813  
 Oxygen Sensor Converter .....691207-1  
 Pressure Sensor (qty. 2) .....691204-50  
 Cable Assembly, Control Valve, 50 ft. ....693005-2  
 Cable Assembly, Pressure Sensor, 50 ft. (qty. 2) .....693008-50  
 Cable Assembly, O<sub>2</sub> Sensor, 50 ft. ....693009-2

## EPC-110 Dimensions

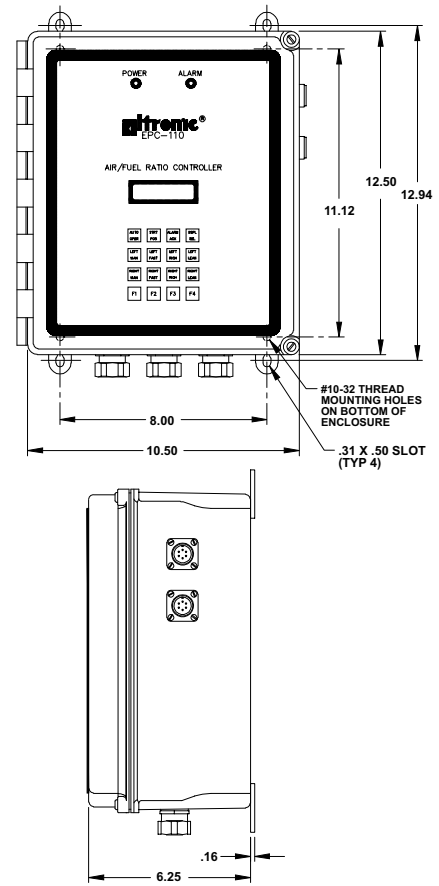

## EPC-100E/150 Dimensions

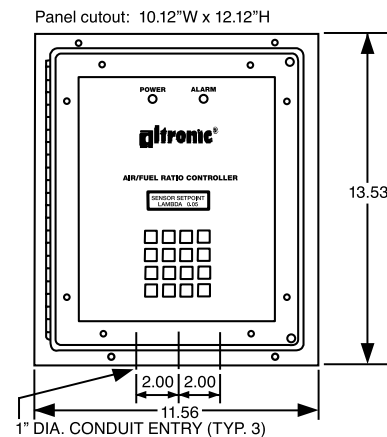

# ALTRONIC

A Member of the HOERBIGER Group

712 Trumbull Avenue / Girard, Ohio 44420  
 (330) 545-9768 / Fax: (330) 545-9005  
 www.altronic-llc.com Email: sales@altronic-llc.com

FORM EPC-110/100E/150 8-22 ©2022 Altronic, LLC