

Operating Manual

AFR-500 AIR-FUEL CONTROLLER

Form AFR-500 OM 8-21



1.0 SYSTEM DESCRIPTION

- 1.1 The Altronic AFR-500 is a stand-alone air fuel ratio controller designed for use on carbureted natural gas-fueled engines. It employs microprocessor technology, allowing for a high level of sophistication in control strategy, and ease of programming. An innovative approach for user interface and display options are now utilized on this platform. The AFR-500 is designed for use on a variety of engines operating at or near a stoichiometric air/fuel ratio (lambda 0.95-1.00) and is ideally suited for application with 3-way catalytic converters. The AFR-500 is designed to be mounted in the engine/compressor control panel
- 1.2 A dual H-bridge control output incorporated into the AFR-500 allows for its use on any engine application with a single fuel gas regulator or stepper motor. A heated wideband Lambda sensor "UEGO" is used in the exhaust stream to sense the actual exhaust Lambda value, and a thermocouple input determines when the proper exhaust temperature has been reached to allow for accurate air fuel ratio operation. The system fuel control valve installed in the fuel line to the carburetor is precisely adjusted under microprocessor control to maintain the correct engine air-fuel ratio. The desired air/fuel ratio can be easily adjusted by changing the control target set point by changing the internal Modbus register values from any communication capable device such as a PLC, PC, DE-4000 or touch screen display.
- 1.3 The AFR-500 has a browser-based configuration tool that can access the internal MODBUS registers via the various communication ports provided.
- 1.4 Power requirement is 24 Vdc, 5 amps maximum.
- 1.5 The AFR-500 also incorporates pre- and post-catalyst temperatures, an RPM input for speed sensing, diagnostic functions and auxiliary inputs and outputs.

WARNING: DEVIATION FROM THESE INSTRUCTIONS MAY LEAD TO IMPROPER ENGINE OPERATION WHICH COULD CAUSE PERSONAL INJURY TO OPERATORS OR OTHER NEARBY PERSONNEL.

2.0 SYSTEM COMPONENTS

- 2.1 Parts from each group below are required for each installation:

AFR-500 Control Module	691790-1
Control Valve, 0.75" NPT Piston-Style Stepper, <250 HP.....	690153-1
Control Valve, 1.5" NPT Piston-Style Stepper, <250 HP	690154-5
Control Valve, 1.5" NPT Piston-Style Stepper, <500 HP	690154-2
Control Valve, 1.5" NPT Piston-Style Stepper, <1000 HP.....	690154-1
Control Valve, 1.0" NPT Butterfly-Style Stepper, <500 HP.....	690210-1
Control Valve, 2.0" NPT Butterfly-Style Stepper, <1000 HP.....	690220-1
Control Valve, 2.5" NPT Butterfly-Style Stepper, <1500 HP.....	690225-1
Control Valve, 3.0" NPT Butterfly-Style Stepper, <2000 HP	690230-1
Control Valve, 1.0" NPT Fuel Pressure Control, <500 HP.....	690318-1

- 2.2 691808-1 Wideband Sensor Accessory Kit

Wideband Oxygen Sensor	691806
Cable Assembly, Control Valve, 25 ft.....	693005-1
Cable Assembly, Wideband Oxygen Sensor, 25 ft.....	693226-1

- 691808-2 Wideband Sensor Accessory Kit

Wideband Oxygen Sensor	691806
Cable Assembly, Control Valve, 50 ft.....	693005-2
Cable Assembly, Wideband Oxygen Sensor, 50 ft.....	693226-2

- 2.3 See Figure 1 for general layout of AFR-500 components.

3.0 MOUNTING THE AFR-500

- 3.1 Operating temperature range is -4°F to 158°F / -20°C to 70°C. Humidity specification is 0-95%, non-condensing. Mount the AFR-500 inside a control panel, preferably off the engine, in such a manner as to minimize exposure to vibration.
- 3.2 See Figure 2 for mounting dimensions
- 3.3 Overall mounting is simple as it uses DIN rail clips that are integrated into the enclosure end caps. To remove the device there are screwdriver slots that allow the technician to apply pressure and release one side from the DIN rail. Be sure to mount the device so that the removal slots are accessible.

4.0 MOUNTING THE UEGO OR WIDE-BAND SENSOR

- 4.1 The Lambda sensor should be installed in the exhaust system between the engine and the catalytic converter and/or muffler. The mounting location should be as close to the exhaust manifold of the engine as possible. The tip of the sensor should be exposed to the unobstructed flow of the exhaust gases from all cylinders of the engine. The sensor should be mounted near, but before, the exhaust stack. Once the downstream position of the wideband Lambda sensor has been determined in the exhaust system, the bung should be mounted between 9 o'clock and 3 o'clock. Condensation buildup can destroy a sensor very quickly. Mounting the sensor between 9 o'clock and 3 o'clock protects it from water build-up at the bottom of the exhaust pipe. If there is sufficient space between the top of the exhaust pipe and other obstructions, mounting the sensor at 12 o'clock is ideal.

NOTE: A WELDMENT BOSS MAY BE REQUIRED FOR SENSOR INSTALLATION IN SOFT OR THIN WALL EXHAUST SYSTEMS.

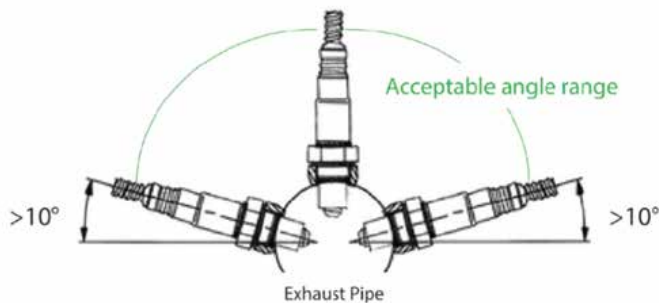

- 4.2 DO NOT locate the sensor in a coupling or in a location where the exhaust gas flow is uneven due to obstructions or sharp bends. The sensor location should allow easy access since periodic sensor replacement may be required in some applications. The location should not subject the exterior shell of the sensor to an ambient air temperature greater than 350°F.
- 4.3 Drill, tap, and spot face a hole in the exhaust pipe at the selected location. A flat, smooth-sealing surface is required to assure accurate readings since air or exhaust leaks will impact sensor operation. See Figure 4 for details.
- 4.4 New sensors are packaged with an anti-seize compound applied to the threads. There is no need to apply additional anti-seize unless reinstalling a used sensor. If required, use high temperature anti-seize very sparingly and apply only to the sensor threads. Sensors should be torqued to 28-34 lb.-ft.
- 4.5 LSU 4.9 Connector Pinout Table
 - 1 Pump Current (IP)
 - 2 Virtual Ground (VM)
 - 3 Heater (H-)
 - 4 Heater (H+)
 - 5 Trim Resistor (IA)
 - 6 Nernst Voltage (UN)

5.0 MOUNTING THE K-TYPE THERMOCOUPLES

- 5.1 An exhaust temperature thermocouple is used to monitor the temperature of exhaust gases near the exhaust Lambda sensor. It should be mounted as close as possible to the Lambda sensor. As with the Lambda sensor, the location should be easily accessible, and the tip of the probe, which should be enclosed by a thermowell, should be surrounded by unobstructed exhaust flow.
- 5.2 Only ungrounded thermocouple probes can be used with the AFR-500. Grounded type thermocouples will not function correctly. Resistance from either lead of the thermocouple to the probe shell should be 2 megohms or greater.

6.0 MOUNTING THE FUEL CONTROL VALVE

- 6.1 In order to regulate the fuel, an electronically controlled valve is connected in series between each regulator and carburetor. The valve should be installed as close to the fuel inlet of the carburetors as possible. The distance from the valve to the carburetor inlet should not exceed 12 pipe diameters in length. The valve should be installed with the control cable connector from 45 to -45 degrees.
- 6.2 Multiple types of fuel regulating valves are currently available, the stepper motor controlled valves are:
 - Altronic part number 690153-1
 - Altronic part number 690154-1
 - Altronic part number 690210-1
 - Altronic part number 690220-1
 - Altronic part number 690225-1
 - Altronic part number 690230-1

Additionally, pressure regulating control valves, APR-1 and AGV-5 are also available.

See valve drawings at end of document for details and flow characteristics

- 6.3 If possible, connection piping should be of the same diameter as currently in use. The threaded connection to the valve body may require the use of thread adaptors. If adaptors are used, proper plumbing procedures must be followed.
- 6.4 The stepper control valve is connected to the AFR-500 using the 693013-1 cable. This cable must not be run in the same conduit as the ignition primary or other Lambda sensor or thermocouple wires. A minimum distance of 4 to 6 inches should be maintained between AFR-500 wiring and other engine wiring.

7.0 ELECTRICAL HOOK-UP

- 7.1 The power connections to the AFR-500 must be in accordance with the National Electrical Code. The AFR-500 is suitable for installation in Class I, Division 2, Groups C and D locations.
- 7.2 An external fuse (5 amp max.) near the power source is recommended.
- 7.3 The AFR-500 can be powered in one of the following ways:
 - 24 volt battery with charger (5 amp min. output).
 - DC power supply capable of furnishing 24 Vdc, 5 amps.
 - If APR or AGV output actuator is used its power requirement is in addition to the AFR unit.
- 7.4 Power wiring and INST wiring must be in separate conduits and conduit entries into the panel containing the AFR-500 to avoid undesired electrical interaction.
- 7.5 Input power supply wires (16 AWG minimum) should connect to the +24 volt and GND supply terminals of the main terminal block.
- 7.6 Using the 693013-x cable connected to the stepper motor routes it to the dual H-bridge outputs. Refer to the chart below for connections. An additional fea-

NOTE: FOR DETAILED INSTRUCTIONS COVERING THE GAS CONTROL VALVE, REFER TO CORRESPONDING DOCUMENTS.

NOTE: VOLTAGE AND CURRENT SUPPLIED MUST BE SUFFICIENT TO OPERATE ALL DEVICES USED IN THE INSTALLATION. IF THE APR-1 IS USED, THE VALVE CURRENT MUST BE ADDED TO THE REQUIREMENTS SHOWN.

ture of the dual output H-bridges is that they can be utilized to drive different inductive actuators when not being used with a stepper control valve.

OUT bridge 2A	693013-1 PIN-B / BLUE
OUT bridge 2B	693013-1 PIN-A / BLACK
OUT bridge 1A	693013-1 PIN-C / WHITE
OUT bridge 1B	693013-1 PIN-F / ORANGE

7.7 The Lambda sensor is connected via shielded cable P/N 693226-1. This should be run in conduit only with the AFR-500 thermocouple connections. These cables should enter the panel containing the AFR-500 and connect to the terminal block "VM" through "IA" as shown in the chart below.

7.8 The cable provided is terminated with weather-tight connectors which mate to the Lambda sensors provided by Altronic. The shield wire (green wire at connector must be connected to the exhaust piping near the sensor. This shield will assist in rejecting noise from other wiring which could affect the Lambda sensor signal. Refer to Figures 4 and 5.

1	GREEN	IP
2	BLACK	VM
3	BLUE	H-
4	RED	H+
5	ORANGE	IA
6	WHITE	UN

7.9 The pre and post catalyst thermocouples (24 AWG min., type K extension) wires should be run in a conduit only with the AFR-500 Lambda sensor wires. The yellow wire should be connected to the TCK_1+ terminal and the red wire to the TCK_1- terminal for pre-catalyst temperature monitoring. The post catalyst TC is connected to TCK_2+ and TCK_2-.

NOTE: ENGINES USING POSITIVE GROUND DC ACCESSORIES OR STARTER MOTORS WILL REQUIRE A SEPARATE, DEDICATED, UN-GROUNDED POWER SUPPLY FOR THE AFR-500.

8.0 THEORY OF OPERATION

8.1 In addition to providing the final cut regulation function, the primary task of the AFR-500 is to accurately control the exhaust air fuel ratio (AFR) of an engine. Control should be maintained through reasonable load and fuel BTU variations.

8.2 Three-way catalysts are used to oxidize CO and HC and to reduce NOx. These processes require high temperature and correct AFR control. Catalysts perform best for all emissions when operated near the stoichiometric AFR.

8.3 The stoichiometric AFR is the AFR at which exactly the required amount of air (Lambda) is present to completely burn all of the fuel. Because no engine can perform perfect combustion, typical emission by-products include Lambda, HC, NO, and CO even though the engine is running at stoichiometry. The stoichiometric AFR is determined by the chemical composition of the fuel, thus they are different for each fuel, or BTU rating.

**(e.g., Methane => 16.9:1 and Gasoline => 14.70:1)
Pipeline natural gas Lambda 1 is typically about 17.0:1**

8.4 Because the fuel type is not always known, it is often easier to specify the AFR target in terms of Lambda. Lambda is an indicator of AFR normalized to the appropriate stoichiometric AFR.

(Lambda Actual AFR/Stoichiometric AFR)

Lambda for stoichiometric combustion would be 1.0, no matter what fuel is used.

Lambda > 1 = Lean, Lambda < 1 = Rich.

8.5 A wide band Lambda sensor (Lambda sensor) is used to provide exhaust AFR

feedback to the AFR-500. This type of sensor creates an output signal used to indicate the amount of Lambda in the engine exhaust. Characteristics of the sensor include: an integrated heater circuit which can draw up to 3A, sensitivity is linear across the range of the sensor. The output signal provides a very suitable means of controlling just rich of Lambda 1.0, which is the AFR range required to obtain best catalyst efficiencies for methane-based fuels.

- 8.6 A type K thermocouple is used to assure that exhaust temperatures are high enough for correct operation of the system before closed loop control is enabled. An additional thermocouple is used to monitor outlet temperature. The AFR-500 is designed for use on small engines where the catalyst is assumed to be close to the engine. The engine out temperature is assumed to be representative of the catalyst in temperature. The three shutdown thresholds are Engine/Cat In temperature too high, Cat Out temperature too high, and Catalyst temperature rise too high. Temperature limit setpoints are provided to create a catalyst protection shutdown capability.
- 8.7 An electronic valve is used to create a variable restriction between the fuel pressure regulator and the carburetor inlet. This restriction is used to adjust the effective inlet pressure seen by the carburetor and results in a mechanical adjustment of the air/fuel mixture delivered by the carburetor. A control loop adjusts the restriction by moving a spool inside the valve. An Altronic Pressure Regulator is a voice coil consisting of a permanent magnet armature and a voice coil winding. Using high resolution electronics, analog feedback provides accurate linear positioning capability. The voice coil used provides pure analog traversing for a full stroke of 0.300" with an initial dead band of 0.050". This affords soft entry of gas, and force balancing.
- 8.8 The AFR-500 adjusts the actuator to maintain a specific setpoint value from the Lambda sensor. When the value is above the Lambda target voltage, the system is richer than desired, and the control valve is moved in a closing direction to further restrict fuel flow to the carburetor. Conversely, when the system is leaner than desired, and the valve position is opened to reduce the restriction of fuel flow.
- 8.9 Control target setpoint must be determined with the use of an exhaust analyzer to locate the operating point of lowest stack emissions. The target value is adjustable in the AFR-500 through the configuration tool and Modbus registers. The resulting system provides accurate and stable control of air/fuel ratio which results in high catalyst efficiencies and reduced stack emissions.

9.0 PRE-START INSTALLATION CHECKLIST

- 9.1 Before applying power to the AFR-500:
 - A. Measure the power supply voltage to assure voltage is within limits (18-32V or 24V nom). Leave unit unpowered.
 - B. With the main terminal block disengaged, measure voltage between yellow and red thermocouple wires. The voltage should be 0.80-1.50mV for temperatures of 60-100°F. This verifies that thermocouple wires are terminated. If engine has been running, measurements will be higher, reflecting higher actual temperatures.
 - C. With the terminal block still disengaged, measure resistance between the red wire and the still-connected earth ground terminal. Resistance should be very high or open circuit. Repeat measurement between yellow wire and earth ground. This verifies that thermocouples are ungrounded and that wires are not shorted in conduit.
- 9.2 After installation with the AFR-500 powered up and the engine not running:
 - A. A compatible User Interface may be connected via one of the serial access ports.
 - B. Data display screen for exhaust temperatures should indicate ambient

temperatures.

- C. Stepper Control valve operation should be verified by creating a start position command. This can be done from the User Interface or by grounding the Digital Input 3 terminal. Visual confirmation can easily be done if the valve is not yet fully installed in the fuel line. During the start position activity, the stepper valve plunger should be fully retracted, then positioned near the middle of its travel. No movement, erratic movement, or movement in the wrong direction will result from incorrect wiring of the stepper cables.
- D. If the APR-1 Pressure Regulator valve is used, employ an appropriate pressure gauge connected to the outlet of the regulator to confirm gas is being supplied at the desired pressure.
- E. See User Interface for default values.
- F. Configure catalyst protection thresholds. Reasonable value ranges should be configured based on the recommendations of the catalyst manufacturer. This can be done by sending the values to the Modbus registers list registers for each successive setup parameter:

Exh Temp Hi = (1000 to 1250°F)
Cat Out Hi = (1100 to 1250°F)
Cat Rise Hi = (100 to 300°F)

NOTE: SETTINGS SHOULD BE ESTABLISHED BASED ON THE RECOMMENDATION OF CATALYST MANUFACTURER.

- 9.3 When all of these checks have been made successfully, move on to the Start-Up Procedure.

10.0 START-UP PROCEDURE

10.1 Before starting engine:

- A. Check for fuel leaks where the fuel line was modified.
- B. Verify that catalyst over-temp thermocouples and thresholds are in place and functional according to catalyst provider requirements and recommendations.
- C. Be sure that the power screw adjustments on carburetors are fully open or fully rich. If these adjustments are not fully open, the control range of the stepper control valve will be limited.
- D. If the alarm outputs of the AFR-500 are being used, temporarily disconnect or override these signals so that an alarm indication will not shut down the engine during setup.
- E. Verify that the catalyst protection output is wired and functional to cause a shutdown in an over temperature condition.
- F. Ground Digital Input Terminal 3 or send a Modbus command to Modbus register 40081. If a user interface is used Press F1, then press START POS on the AFR-500 interface to reset stepper position and enable the warm-up delay.
- G. Place AFR-500 controller in manual mode by pressing appropriate key on the User interface device or writing to Modbus register 40073
- H. Start and warm-up engine.

10.2 With the engine running:

- A. Load engine to desired operating point.
- B. Verify that the exhaust temperature data screen is displaying reasonable values, and that the temperatures exceed 650°F.
- C. Enable automatic control from an optional User interface device by pressing the AUTO key or writing to Modbus register 40073. The unit should begin adjusting the fuel control valve, trying to control the engine air/fuel

ratio. Use any diagnostic warnings which may occur to trouble-shoot the system. A Rich or Lean limit error is a good indication that the pressure regulator may need to be adjusted.

- D. Once the unit has gained control of the engine adjust the fuel pressure regulators until the AFR-500 is controlling with the stepper valve positions near 1000 steps. This is approximately the middle of the valve's control range.

10.3 Fine tune the control setpoints:

- A. Using an exhaust analyzer, determine the Lambda set-point value which results in the best emission performance. This can be done by adjusting the Lambda target value in Modbus 40036 from an optional User interface or setup device. Alternatively, manual mode can be used to adjust the control valves to the positions which give the best emissions performance. The Lambda target value should be adjusted to match the actual sensor-measured value displayed in Modbus register 30018.
- B. The control gain rate and default stepper positions can also be adjusted via the appropriate Modbus registers, however, the default values represent the best typical values for these parameters.

10.4 Once the system is controlling at the best emissions point, the alarm output can be re-enabled.

10.5 The AFR-500 setup is now complete; the unit should be controlling the engine.

11.0 AFR-500 MODBUS REGISTER LIST

The 10xxx registers are read-only binary and support Modbus standard function 1. These registers are read in multiples of 8 (1 byte) addressed at each 8 bit boundary (10001-10008, etc.). A single Boolean read from registers 10001 to 10064 can be made which will return all 64 values as a group of 8 bytes.

REGISTER	BINARY REGISTER VALUES
10001	Save Position
10002	Low Supply Voltage
10003	Current State
10004	Control Loop Mode
10005	Reserved
10006	Reserved
10007	Spare Status
10008	Automatic Control Active
10009	Getting Richer
10010	Very Rich
10011	Rich
10012	On Target
10013	Lean
10014	Very lean
10015	Getting Leaner
10016	Lean Limit
10017	Rich Limit
10018	Stepper Resetting
10019	Reserved
10020	Catalyst In High Temperature Alarm

REGISTER	BINARY REGISTER VALUES
10021	Catalyst Out High Temperature Alarm
10022	Catalyst Delta High Temperature Alarm
10033	Reserved
10034	Reserved
10035	Reserved
10036	Reserved
10037	Reserved
10038	Reserved
10039	Reserved
10040	Reserved
10041–52	Reserved
10053	Reserved
10054	Reserved
10055	Reserved
10056	Reserved
10057	Reserved
10058–64	Reserved
10065	Reserved
10066–68	Reserved
10069	Reserved
10070–72	Reserved
10073–74	Reserved

The 30xxx registers are read-only, 16 bit, analog values. The Modbus standard function 4 is supported.

REGISTER	16-BIT INPUT REGISTER VALUES
30001	Input Bit Mirror 10016-10001
30002	Input Bit Mirror 10032-10017
30003	Input Bit Mirror 10048-10033
30004	Input Bit Mirror 10064-10049
30005	Input Bit Mirror 10080-10063
30006	Input Bit Mirror 10096-10081
30007	Input Bit Mirror 10112-10097
30008	Input Bit Mirror 10128-10113
30009	SUPPLY INPUT VOLTAGE 0.1v/count
30010	Engine Speed RPM
30011	EXH TEMP Catalyst In 0.1deg F/count
30012	Catalyst Exhaust Temperature 0.1 deg F/count
30013	Catalyst Outlet Temperature 0.1 deg F/count
30014	Catalyst Temperature Rise 0.1deg F/count
30015	Reserved
30016	Reserved
30017	CJ125 Status

REGISTER	16-BIT INPUT REGISTER VALUES
30018	Exhaust Lambda Input (Lambda measured value 0.001 increment)
30019	Exhaust Lambda Control
30020	Reserved
30021	Reserved
30022	Reserved
30023	Reserved
30024	Reserved
30025	Reserved
30026	Reserved
30027	Reserved
30028	Reserved
30029–30	Reserved
30031	Reserved
30032–37	Reserved
30038	Reserved

The 40xxx registers are read/write, 16-bit, analog values and they support the Modbus standard functions 3, 6 and 16. These registers may have new values written to them in order to make setpoint adjustments from a remote location.

REGISTER	16-BIT READ/WRITE REGISTER VALUES
40001	Reserved
40002	Reserved
40003	Reserved
40004	Reserved
40005	Reserved
40006	Reserved
40007	Reserved
40008	Reserved
40009	Reserved
40010	Reserved
40011	Reserved
40012	Reserved
40013	Reserved
40014	Reserved
40015	Reserved
40016	Reserved
40017	Reserved
40018	Reserved
40019	Output Mode (0 for stepper, 1 for APR 2 for 4-20 ma)
40020	Modbus Node number (default of 01)
40021	Number of flywheel teeth
40022	Reserved
40023	Reserved
40024	Reserved

REGISTER	16-BIT READ/WRITE REGISTER VALUES
40025	Reserved
40026	Reserved
40027	Reserved
40028	Reserved
40029	APR-1 Pressure Setpoint WC in 0.01 increments
40030	APR-1 Pressure Kp
40031	APR-1 Pressure Ki
40032	APR-1 Pressure Kd
40033	Reserved
40034	Reserved
40035	Reserved
40036	Exhaust Lambda Setpoint
40037	Exhaust Lambda Kp
40038	Exhaust Lamda Ki
40039	Exhaust Lambda Kd
40040-59	Reserved
40060-69	Reserved
40070	Reserved
40071	Reserved
40072	Reserved
40073	MANUAL/AUTOMATIC
40074	Reserved
40075	Manual Increase 25 steps
40076	Manual Decrease 25 steps
40077	Manual Increase 100 steps
40078	Manual Decrease 100
40079	Default Stepper Position
40080	Reserved
40081	F1 Start write 1
40082	Reserved
40083	Reserved
40084	Reserved
40085	Catalyst Input High Setpoint 0.1 deg F/count
40086	Catalyst Output High Setpoint 0.1 deg F/count
40087	Catalyst Delta High Setpoint 0.1 deg F/count
40088	Alarm Acknowledge (acknowledge with 1)
40089-97	Reserved
40098	Heater On Temperature Setpoint

FIGURES SECTION:

- FIGURE 1 AFR-500, GENERAL INSTALLATION LAYOUT: SINGLE BANK
- FIGURE 2 AFR-500, MOUNTING DETAIL
- FIGURE 3 TYPICAL EXAMPLE OF 3-WAY CATALYST OPERATION
- FIGURE 4 BOSCH UEGO LSU4.9 Lambda sensor DETAIL
- FIGURE 5 ALTRONIC UEGO LSU4.9 Lambda sensor HARNESS

FIGURE 1 AFR-500, GENERAL INSTALLATION LAYOUT: SINGLE BANK

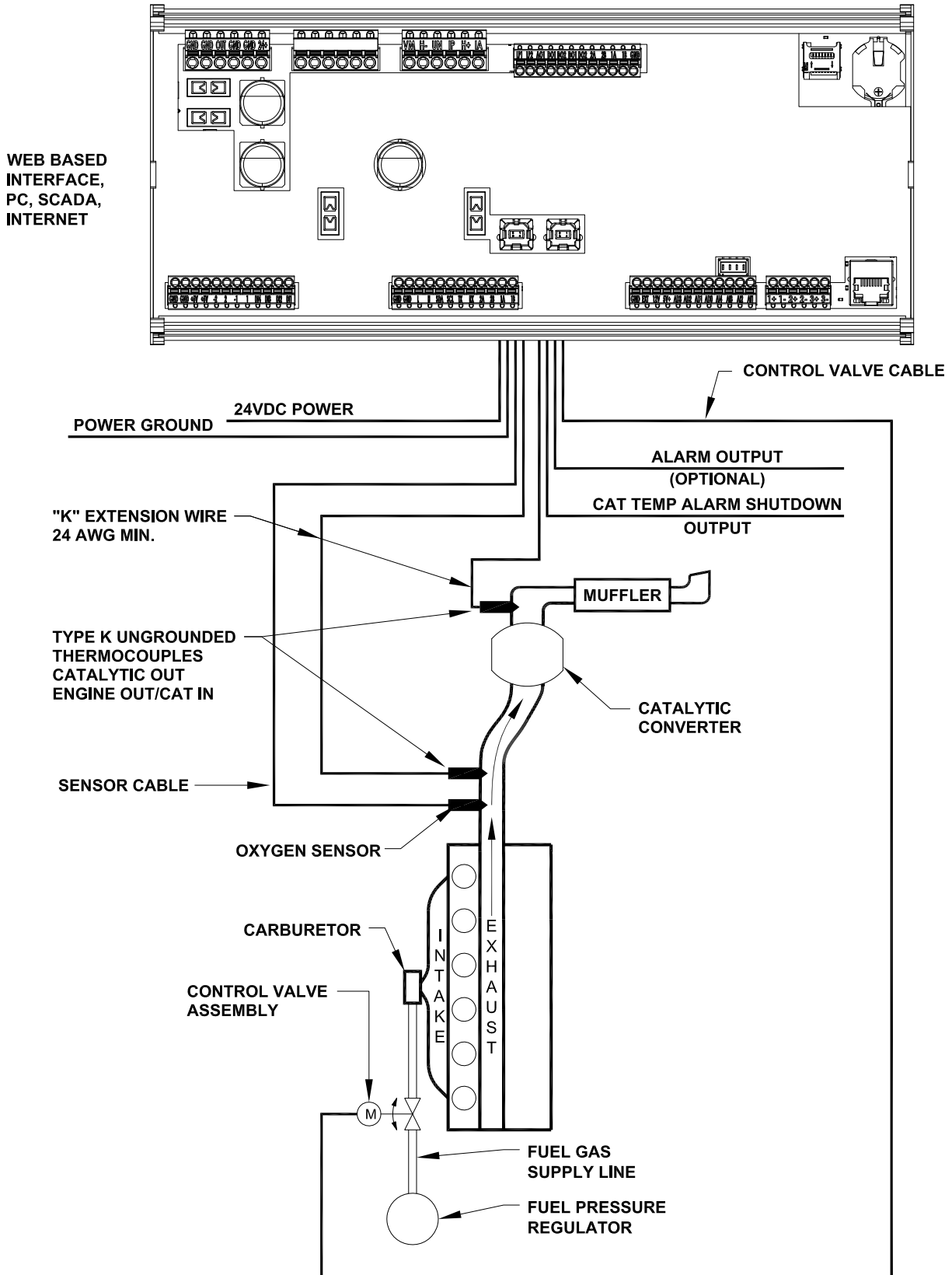

FIGURE 2 AFR-500, MOUNTING DETAIL

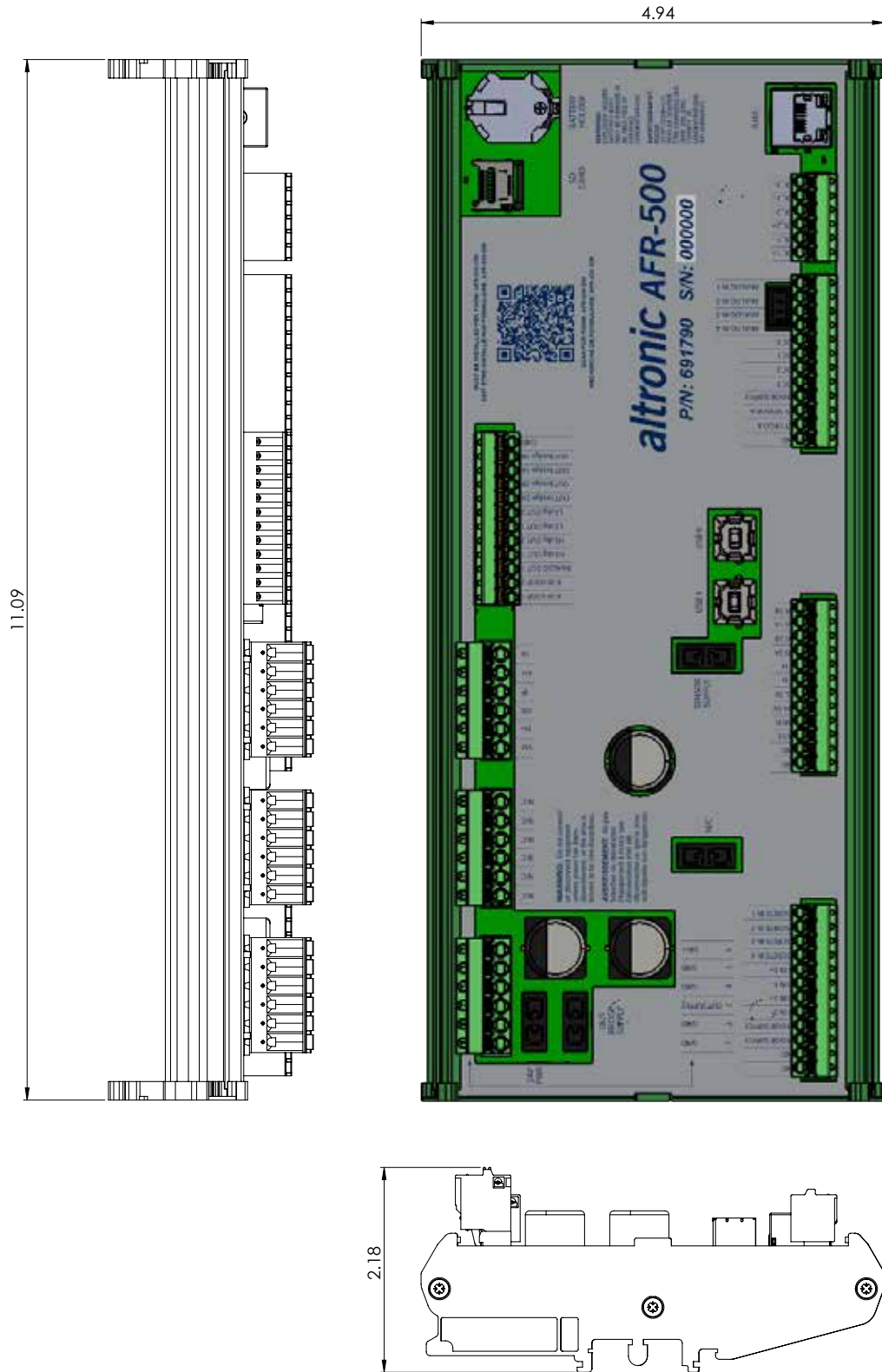
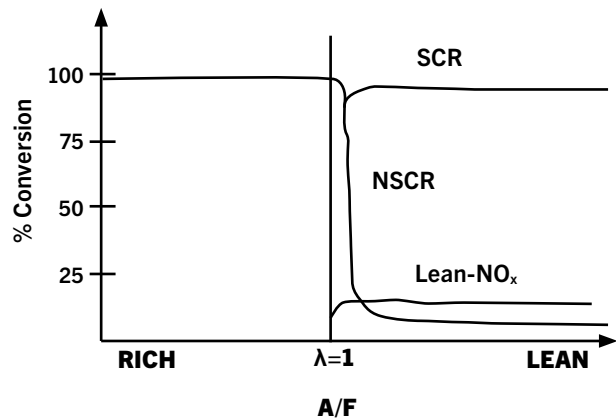

FIGURE 3 TYPICAL EXAMPLE OF 3-WAY CATALYST OPERATION

Best overall emissions performance will be slightly rich (to the left) of LAMBDA 1.0 as shown in the graphs below

The suggested starting point is in the range of LAMBDA 0.95 to 0.97 for a new installation



Catalyst performance for oxides of nitrogen (NO_x)

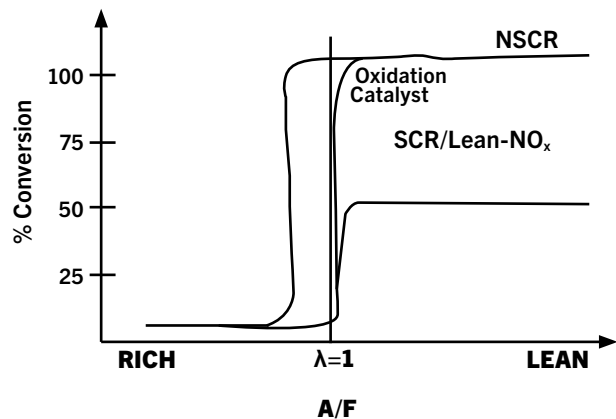

Catalyst performance for carbon monoxide (CO)

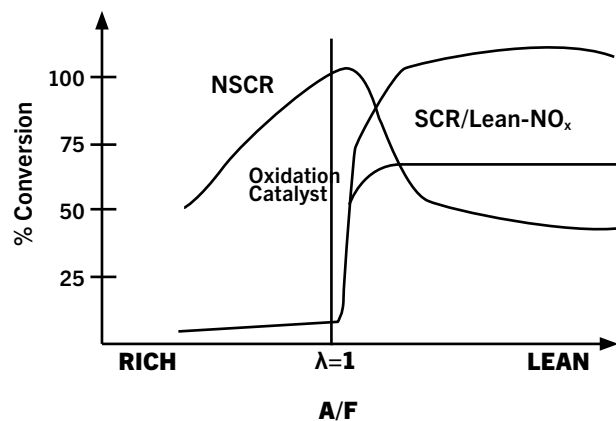

Catalyst performance for non-methane hydrocarbons (NMHCs)

FIGURE 4 BOSCH UEGO LSU4.9 LAMBDA SENSOR DETAIL

Excessively rich environments (Lambda 0.75 or richer) will cause more rapid contamination than stoich (Lambda=1.0) operation. Lean and even free-air operation is usually not a problem. Environments devoid of water vapour should be avoided (this is also usually not a problem as H₂O is a by-product of combustion). Excessive oil consumption will rapidly contaminate and physically clog the sensors internal structure. Bosch recommends oil consumption of less than 0.7L/1000km (~2 US-pints/1000 miles). Other common contaminants include, but are not limited to, Zinc (galvanized parts), Ethylene Glycol (anti-freeze) and Silicon (many gaskets). Other environmental conditions likely to cause a shortened sensor life include:

1. Operating the sensor hotter or cooler than its optimal heat range (see below for more info)
2. Placements where condensation is likely to enter the sensor during warmup or operation. Bosch recommends orientations where the leads point up from the horizontal by more than 10°.

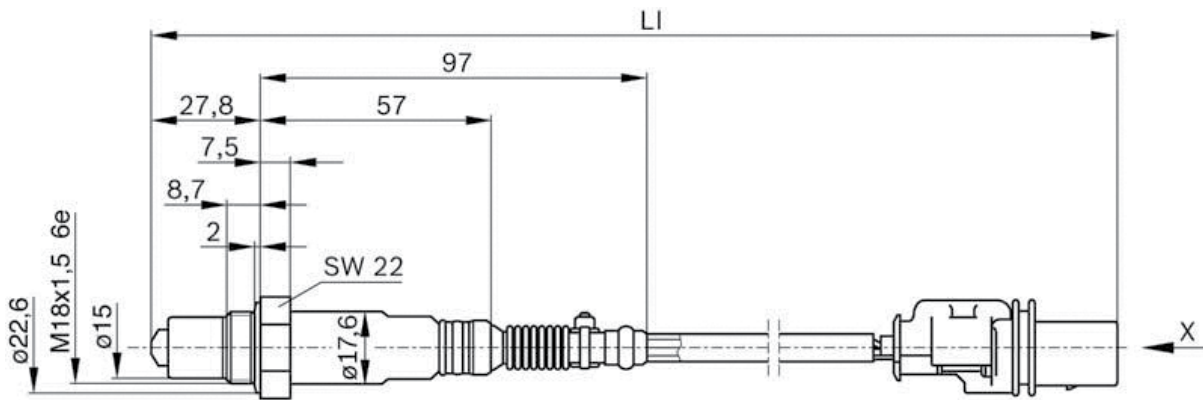

- 1 Pumping electricity (red)
- 2 Virtual ground (yellow)
- 3 Heater clock - (white)
- 4 Heater clock + U Batt (grey)
- 5 Trimming potentiometers (green)
- 6 Nernst voltage (black)

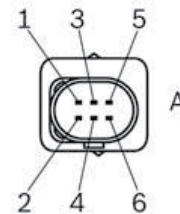

FIGURE 5 BOSCH UEGO LSU4.9 LAMBDA SENSOR HARNESS

